

# Chevrolet **ASTRO VAN AWD** • GMC **SAFARI VAN AWD**

## Front

**REFER TO TRANSFER CASE INFORMATION ON THE FACING PAGE.**

Refer to Notices on pages 28-29.

Refer to Automatic Transmission/No Power information on pages 32-35.

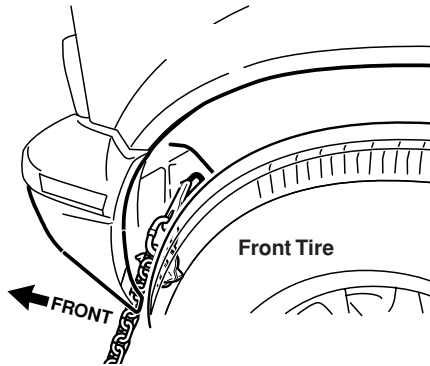

## Rear

**REFER TO TRANSFER CASE INFORMATION ON THE FACING PAGE.**

Refer to Notices on pages 28-29.

Refer to Automatic Transmission/No Power information on pages 32-35.

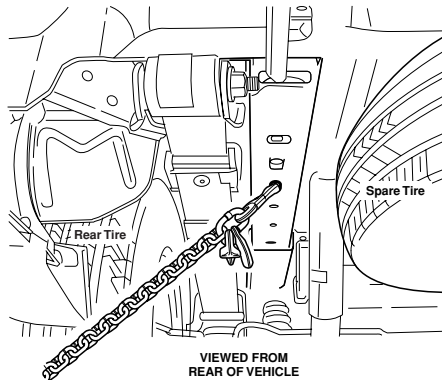

### **All-Wheel Drive Transfer Case**

NOTICE: When towing most all-wheel-drive vehicles, use carrier equipment or place a towing dolly under the wheels that would otherwise be on the ground.

NOTICE: To help avoid property damage:

- The steering wheel must be clamped in the straight-ahead position when towing from the front or rear using a clamping device designed for towing service.
- Do not use the vehicle's steering column lock.
- A separate safety chain must be used on each side of the vehicle.

# Towing Recommendations and Guidelines

The following notices describe precautions necessary to prevent damage to towed vehicles. Refer and adhere to these notices whenever towing a GM vehicle. In addition to the general notices below, individual vehicles may require additional precautions due to the vehicle's design, equipment, or other unique features. These vehicle-specific notices are included on the appropriate vehicle page. They should be adhered to in addition to the notices below. The following pages also contain guidelines for vehicle content features that affect towing. These should also be adhered to, as applicable, in addition to all applicable notices. **Failure to follow these notices and guidelines may result in damage to the customer's vehicle.**

These instructions apply to vehicles with standard equipment only. Any optional equipment such as campers, special bodies, front mounted spare tires, trailer hitches, etc. must be given due consideration.

## Front Tow Notices

**NOTICE:** Towing on a vehicle's drive wheels should be avoided, if possible. When towing on the drive wheels, maximum speed and distance limitations must be adhered to and/or a towing dolly may need to be used.

**NOTICE:** When towing most AWD vehicles, a towing dolly must be used on the ground wheels or vehicle damage will occur.

**NOTICE:** Do not tow with sling-type equipment or fascia/fog lamp damage will occur. Use wheel-lift or carrier equipment. Additional ramping may be required for car-carrier equipment. Use safety chains and wheel straps.

**NOTICE:** Towing a vehicle over rough surfaces could damage the vehicle. Damage can occur from vehicle-to-ground or vehicle-to-wheel-lift equipment contact. To help avoid damage, install a towing dolly and raise vehicle until adequate clearance is obtained between the ground and/or wheel-lift equipment.

**NOTICE:** Do not attach winch cables or J-hooks to suspension components when using carrier equipment. Always use T-hooks inserted in the shipping slots.

**NOTICE:** Towing on a vehicle's drive wheels should be avoided, if possible. When towing on the drive wheels, maximum speed and distance limitations must be adhered to and/or a towing dolly may need to be used.

**NOTICE:** When towing most AWD vehicles, a towing dolly must be used on the ground wheels or vehicle damage will occur.

**NOTICE:** Do not tow with sling-type equipment or the rear bumper valance will be damaged. Use wheel-lift or carrier equipment. Additional ramping may be required for carrier equipment. Use safety chains and wheel straps.

**NOTICE:** Towing a vehicle over rough surfaces could damage the vehicle. Damage can occur from vehicle-to-ground or vehicle-to-wheel-lift equipment contact. Install the towing dolly and raise the vehicle until adequate clearance is obtained between the ground and/or wheel-lift equipment contact.

**NOTICE:** Do not attach winch cables or J-hooks to suspension components when using carrier equipment. Always use T-hooks inserted in the shipping slots.

**NOTICE:** Wheel-lift towing pickup trucks models from the rear while loaded with heavy cargo may cause the frame side rails to flex sufficiently, allowing the pickup box to contact the cab and possibly causing damage to the cab and/or box.

**Most Vehicles (\*\*Except Tracker, Saturn ION, Cadillac CTS and Pontiac Vibe\*\*)**

If a vehicle has an automatic transmission with a floor shift and it has no electrical power, the electrical solenoid lock must be overridden to shift from Park (P) to Neutral (N). For the majority of GM vehicles, use the following steps.

1. Push the base of the leather shift lever boot forward with your thumb.
2. Lift the boot and find the white solenoid lever.
3. Move the white lever toward the driver's side to unlock it.
4. While holding the white solenoid lever in the unlock position, press the shift lever button and shift into Neutral (N).
5. Release the solenoid lever and snap the boot back into place.

**Tracker**

1. Apply the parking brake until the end of Step 6.
2. Turn the key to ON or ACC.
3. Find the access hole cover on the driver's side of the console, near the shift lever.
4. Remove the screw and cover.
5. Locate the return plate. Using a finger, move the return plate toward the rear of the vehicle until it stops (figure 8).
6. Move the shift lever into the desired gear.

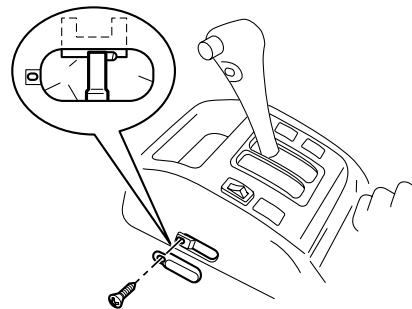

**FIGURE 8**

## Saturn ION

ION is equipped with an electronic park lock actuator. In the event that the ignition key cannot be rotated to the OFF/LOCK position and removed from the lock cylinder, use the following procedure to manually override the electronic park lock actuator.

1. Make sure the vehicle is in Park (P).
2. Using a flat-tipped tool or another key, carefully pry off the cover from the bottom of the steering column (figure 9).
3. Place your index finger through the access hole and locate the end of the electronic park lock actuator plunger (figure 10).
4. Press and hold the plunger toward the driver's side door while rotating the ignition key to the OFF/LOCK position. Remove the key.

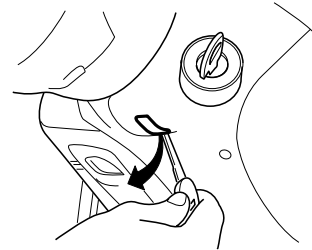

FIGURE 9

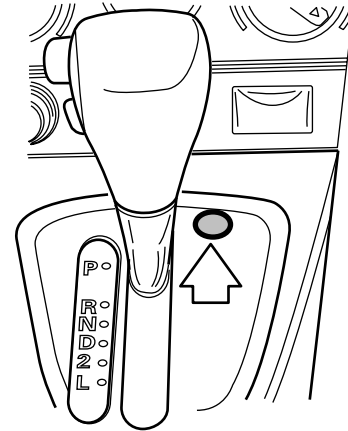

FIGURE 10

### **Pontiac Vibe**

If you cannot shift out of Park (P), ease pressure on the shift lever by pushing the shift lever all the way into Park (P) and releasing the shift lever button as you maintain brake application. Then press the shift lever button and move the shift lever into Neutral (N). If you hold the brake pedal down but still can't shift out of Park (P), do the following:

1. Turn the ignition to LOCK. Make sure the parking brake is applied.
2. Carefully pry the shift-lock override small, round cover from the floor-shift console located to the right of the shift lever (figure 11).
3. Insert the end of a flat-tipped tool into the circular slot and press down firmly.
4. While maintaining brake application, move the shift lever into Neutral (N).



**FIGURE 11**

## Cadillac CTS

Automatic transmission CTS vehicles are equipped with a shift lock release. Use the following procedure to release the shift lever and shift the vehicle into Park (P) under dead battery or low battery voltage conditions.

1. Pull up on the rear part of the leather boot that surrounds the shift lever (figure 12).
2. Fold the boot upward to expose the mechanism beneath the shift lever.
3. Locate and remove the small oval cap near the forward, right side of shift mechanism (figure 13).
4. Using a narrow, pointed tool, press down on the mechanism under the cap so that you can move the shift lever (figure 14).

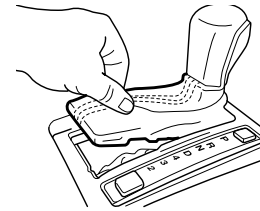

FIGURE 12

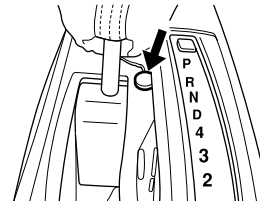

FIGURE 13

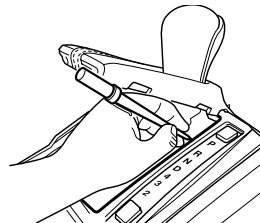

FIGURE 14